









CLASSIC STUDIO EASEL

assembly instructions

For model AA13135.
All necessary tools included.

HARDWARE											
A		4 pcs	C		1 pc	E		1 pc	G		2 pcs
B		4 pcs	D		1 pc	F		2 pcs	H		2 pcs

STEP 1

Assemble the base

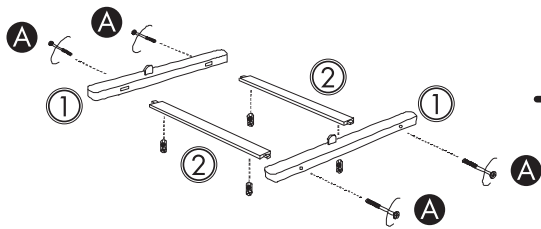

STEP 2

Attach the ratchet column to crossbars

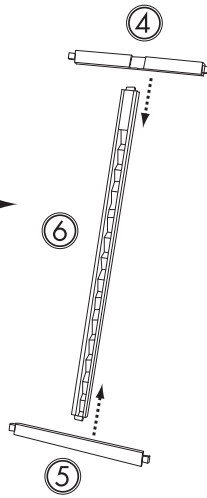

STEP 3

Attach sides to the crossbars

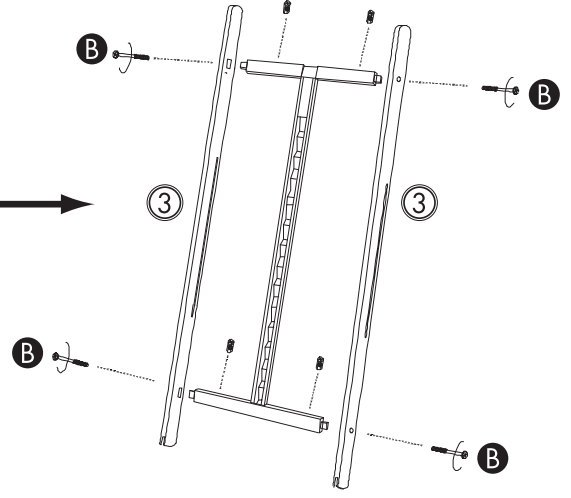

STEP 4

Attach tray to the mast

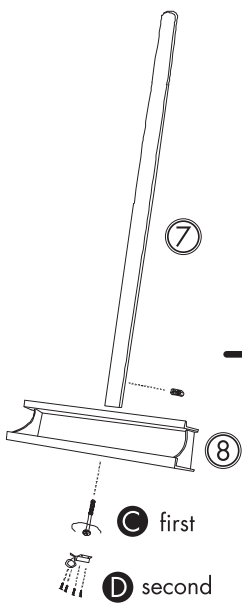

STEP 5

Slide mast into crossbar channel and attach top canvas holder

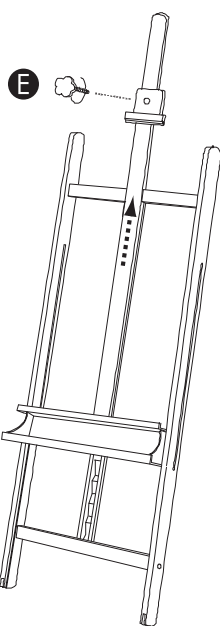

STEP 6

Attach frame to base

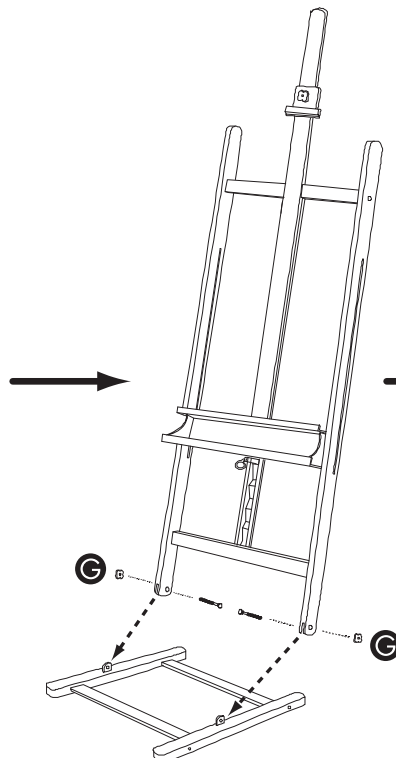

STEP 7

Attach support legs to base and sides

